

Article number: 0102038

Description: Retaining ring J21 DIN472
Spring steel

Measures

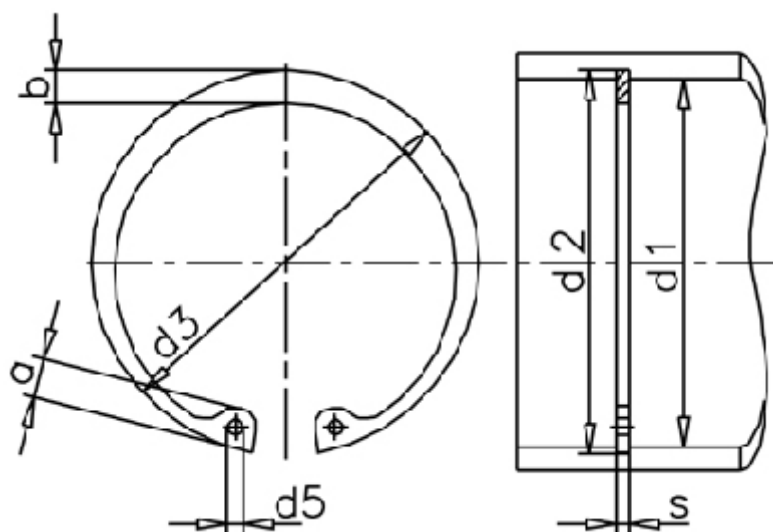

a max	= 4.2	FN kN	= 5.70	t	= 0.50
AN mm ²	= 33.8	FRg kN	= 2.6	tol	= +0,13
b	= 2.4	FR kN	= 7.6	tol	= +0,42-0,13
d1	= 21	g	= 1.0	tol	= -0.06
d2	= 22.0	K kN-mm	= 17.2	Tong	= ZGJ-2
d3	= 22.50	m min	= 1.10	Weight kg/1000	= 1.00
d5 min	= 2.0	Nominal drive	= 1.5		
Description = J 21		s	= 1.00		